



Design of Android and iOS Applications for Mobile Health Monitoring Devices

Anisah Fadhilah¹, Ade Silvia Handayani^{2*}, Ibnu Ziad³, Nyayu Latifah Husni⁴, Siti Chodijah⁵, Mega Hasanul Huda⁶, Nur Agustini⁷, Mieska Despitasi⁸, Riswal Hanafi Siregar⁹

^{1,2,3,4}Departement of Electrical Engineering, Politeknik Negeri Sriwijaya, Jl. Srijaya Negara 30128, Palembang, Indonesia

⁵Professional (Nurse) Program, Universitas Indonesia, Jl. Margonda Raya 16424, West Java, Jakarta, Indonesia

^{6,8,9}The Faculty of Nursing, Universitas Indonesia, Jl. Margonda Raya 16424, West Java, Jakarta, Indonesia

⁷Pediatric Nursing Specialist Program, Universitas Indonesia, Jl. Margonda Raya 16424, West Java, Jakarta, Indonesia

[*ade_silvia@polsri.ac.id](mailto:ade_silvia@polsri.ac.id), anisafadilah03@gmail.com, ibnupoltek1@gmail.com, nyayu_latifah@polsri.ac.id, s.chodidjah@ui.ac.id, megahasanulhuda@gmail.com, tufahati@ui.ac.id, mieska.despitasi@brin.go.id, risw001@brin.go.id,

Abstract. This research proposes a multifunctional wireless health monitoring tool with a display for Android and iOS devices. This research aims to develop a realistic solution for real-time and conveniently accessible health monitoring via mobile devices. The device allows users to test and track health factors such as heart rate, blood pressure, blood oxygen levels, body temperature, and blood glucose. It collects data properly by using wireless technology and sensors. The data is subsequently supplied to the appropriate apps on Android and iOS devices. The data is presented visually in the program, making it instructive and user-friendly. The device's development technique involved extensive testing and validation against established comparators to assure accuracy. The results of this study show that this digital, multi-purpose health monitoring device works well and reliably to give real-time health information. This innovation promotes health monitoring and digital health information access.

Keywords: Android, Application Health, iOS, ISO/EIC 9126 , WBAN

(Received 2023-08-06, Accepted 2023-08-18, Available Online by 2023-08-21)

1. Introduction

In this era of technological advancement, health, and wellness is a significant concern for many people. At the same time, the popularity of smartphones and mobile devices is on the rise. These devices have become an integral part of people's daily lives. Medical software is an essential part of modern, integrated healthcare. Physicians, patients, and healthcare organizations increasingly use it to influence treatment decisions [1]. Therefore, wireless technology integration into the healthcare industry is an excellent opportunity. This technology is a practical and efficient solution for users to monitor their health conditions. In this study, an application is designed that can record and monitor patient data efficiently and accurately. The design of this application uses the principle of IOT (Internet Of Things), which is a principle that aims to expand the benefits of Internet connectivity that is continuously connected [2]. The power of IOT (Internet of Things) is now widely used and has made tremendous contributions to healthcare [3].

WBAN (Wireless Body Area Network) technology obtains the patient's body health data. Wireless Body Area Network (WBAN) provides continuous patient health monitoring without interfering with normal daily activities [4]. The technology is a multi-functional wireless health monitoring device consisting of multiple sensors. The patient's body health data include body temperature, heart rate, blood pressure, oxygen level, and blood sugar. This application design will display various functions of the patient's body health data, such as real-time data display, diagnosis results, diagnosis results graph, health status, clinical data display, and history display. This application is available on Android or iOS-based user smartphones. Smartphones are cell phones based on an operating system with computing capabilities and more advanced connections than telephones. Android and Ios are the most common or dominating operating systems today [5]. Android is a Linux-based operating system. It is based on open-source principles [6]. The iOS operating system is based on UNIX, now widely recognized as an operating system that makes it easy for users to develop applications [5].

Previous research on wireless health monitoring tools has used four parameters : heart rate, body temperature, blood oxygen, and blood pressure. This research adds one more parameter, which is blood glucose level. With the parameter of blood glucose level, patients are expected to know more about their health and can live a healthier life. Thus, the current monitoring tool has five parameters: body temperature, heart rate, blood oxygen, blood pressure, and blood glucose. The application display has been designed to be more efficient and easy to understand by users. It displays several functions such as user login, user register, user profile, health status, results from each sensor graph, real-time data, and user history display. Therefore, this research designs an Android and iOS-based mobile application to get a user-friendly display. The application can make it easier for users to receive data on body health conditions and accurately record patient data.

2. Methods

The design of a multifunctional wireless health monitoring device depicts a brief system block diagram. This aims to find out the general form of the system to be designed to facilitate the hardware design process.

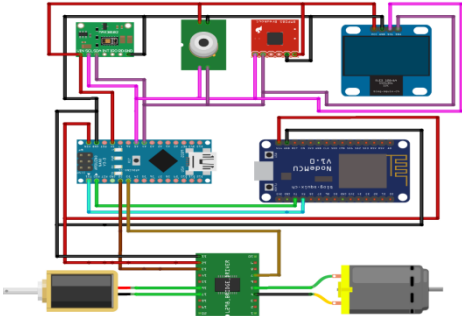

Figure 1. Hardware Schematic Diagram

Figure 1 is the overall circuit design scheme that has been designed. They are using the components of the hardware. The part consists of several sensors, such as the MAX 3105 sensor for blood and blood sugar oxygen levels. MLX 90615 sensor as a body temperature sensor. AP3 models a

blood pressure sensor as a blood pressure and heart rate sensor. a Mini DC motor as an air pressure pump. The Solenoid is a place that regulates the entry and exit of force. As well as essential components such as ESP8266 mini as a wifi module, OLED as a display, and Arduino nano as a program controller.

Figure 2 is a block diagram, a step-by-step wireless health monitoring application that will be designed. They start with the input of clinical data by the patient and begin the sensor detection on the device. After that, the patient's health data is sent to the server to be processed to produce a healthy or unhealthy health status. Android and iOS applications are designed using Flutter software. Flutter is an open-source framework or SDK developed by Google. Flutter helps build interface applications that have high performance and can be published on the Android and iOS platforms. Flutter uses the Dart programming language, developed by Google for general needs (general-purpose programming language). Android and iOS applications use Firebase, a database stored in the Cloud in real-time and supports multi-platforms such as Android and iOS [7].

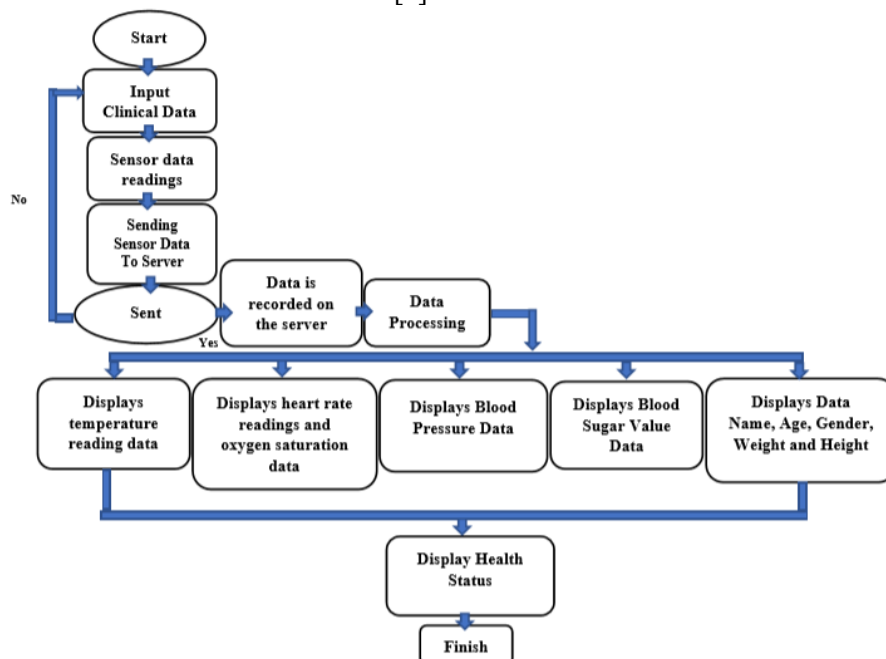
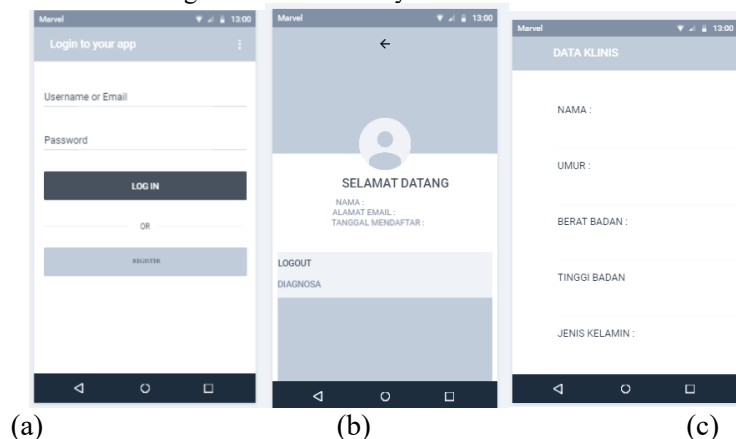

Figure 2. Flowchart System Software



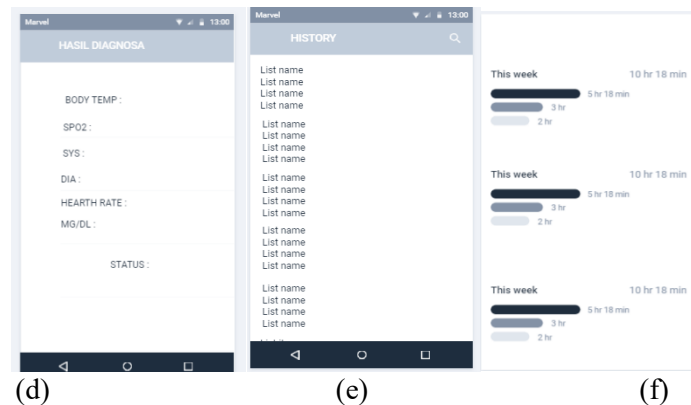

Figure 3. Application Display Design (a) User Login (b) User Profile (c) Clinical Data Input (d) Diagnostic Results (e) User History (f) Graph

Figure 3 is a plan for designing an app to be used as a guide for making apps. Figure 3(a) shows how the Login view looks on Android and iOS apps. Users and admins can put their email address and password in the picture. Figure 3(b) shows that a user and user biography will appear when the Login button is clicked. Figure 3(c) shows a menu for entering clinical data that the user or manager will fill out. Figure 3(d) shows the results of tests or measurements for each element. Figure 3(e) shows the page for the past detection history, and Figure 3(f) shows the page for the graph. This page will show a line graph of the data from each sensor's parameters.

Software testing plays a vital role in the development process because it adopts reliability and ensures the quality of the developed product/project. The main features of software testing are verification and validation. In this stage, the mobile application that has been created will be tested in detail and thoroughly. In this study, application testing uses a world-recognized standard, namely ISO / IEC 9126. ISO/EIC 9126 is one of the international standard frameworks used to test software quality. ISO 9126 was created by the International Organization for Standardization (ISO) and the International Electrotechnical Commission (IEC). This international standard can define the quality of software products [8]. The ISO/EIC features combine several existing quality standards. These standards were developed to identify various aspects of an application to determine compliance with software quality rules. With these measurements, the resulting application can be considered a quality application [9]. This test includes functional testing, suitability testing, and efficiency testing.

This study selectively selected respondents who met certain criteria. Inclusion criteria included ages between 18 and 50 years. A total of 150 respondents participated in this study. This number was selected based on statistical considerations to produce significant and relevant results. The selected respondents represented a wide range of ethnic and geographic backgrounds. The average age of the respondents was 20 years old, and there was an equal number of males and females. All respondents had a high level of smartphone experience. This study focuses on using an application that stores and records patient data. The application is expected to be useful in monitoring the health status of the patient's body. Respondents were given a thorough explanation of the purpose of the study, and the researcher adhered to all ethical standards.

3. Results and Discussion

Results of Multifunctional Wireless Health Monitoring Device

The hardware design of the multifunctional wireless medical device is applied to a red protective box. The system hardware has been successfully made based on the sketch design of the device. Figure 4 shows the hardware of the multifunctional wireless health monitoring device. The sensors are placed inside the protective box with the aim that they can be protected, and the sensors work properly.



Figure 4. Multifunctional Wireless Health Monitoring Device

In Figure 4 above, there are sensors used in this multifunctional wireless medical device. These sensors include the MAX 3105 blood oxygen and blood sugar sensor. MLX 90615 sensor as a body temperature sensor. AP3 models blood pressure sensors as blood pressure and heart rate sensors. Essential components such as mini DC motors and air pressure pumps. The Selenoid is a place that regulates the entry and exit of pressure. As well as the use of ESP8266 mini as a wifi module, OLED as a display, and Arduino nano as a program controller.

After the sensor nodes send the body health detection readings to the central server, the reading data will be processed and displayed on the user's smartphone. Smartphones that have Android and iOS operating systems. The goal is to be accessed efficiently and quickly to get information on the patient's body health.

Multifunction Wireless Health Monitoring App

The software has been successfully created based on the design of the display sketches that have been designed. The software obtained is a multifunctional wireless health monitoring application. Applications that have been integrated with smartphones are made using Flutter SDK software. Android and iOS-based applications to record the health of the patient's body using this sensor are named "I-Health."

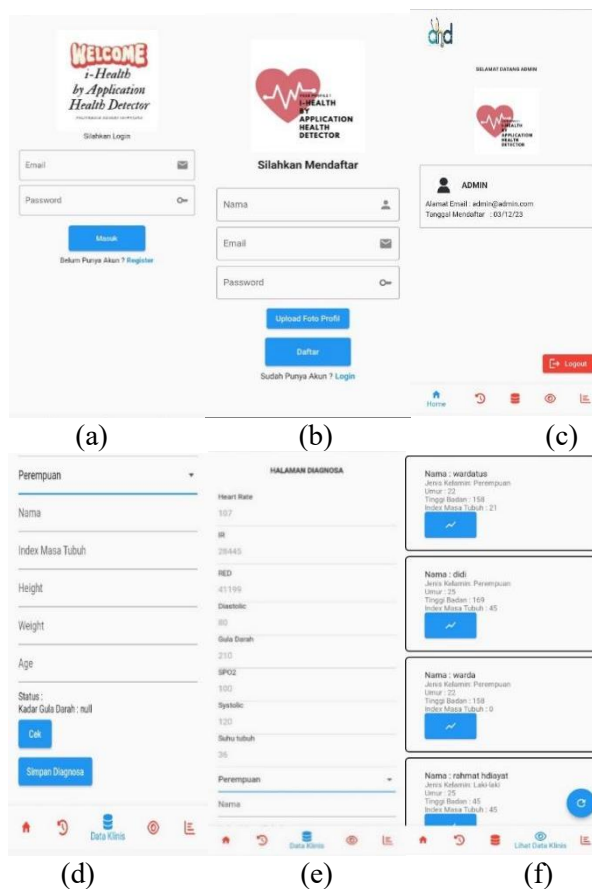

Figure 5. Display result of multifunctional wireless health monitoring application (a) Login (b) register (c) User profile (d) clinical data (e) diagnosis results (f) user history

The user login page consists of filling in the email and password. If the user does not have an account, they are required to register. Figure 5(b) shows the register page, which consists of filling in the desired name, email, and password; the user can return to the login page after registering. Figure 5(c) is the user's profile page, and the button to select another menu is displayed in real-time. Figure 5(d) is the clinical data input page filled in by the user, which consists of gender, name, BMI, weight, height, and age. Meanwhile, Figure 5(e) shows the diagnosis results, which contain data the sensor detects on the device and the user's health status, which will appear when the "check" button is clicked. Furthermore, the data sent to the application displays real-time data. The next page shows the user's previous measurement history, as shown in Figure 5(f).

Application Testing Using ISO/EIC 9126

Respondents in the implementation of this system test our users. The characteristics of respondents are categorized based on the type of user, age, and smartphone operating system of the user. Respondent characteristics based on user

Table 1. Total Respondent

Number of Respondent	150 Respondent
Operation System	Android : 80 iOS : 70
Age	<20 >20

Next is to analyze the data for calculation. The analysis uses the percentage value (%) of the success of the i-health application and the percentage value (%) of errors in the i-health application. These formulas are in the following equation.

Percentage of success of i-health app testing

$$= \frac{\text{Skor Aktual}}{\text{Skor Ideal}} \times 100\% \quad (1)$$

Percentage of i-health app testing errors

$$= \frac{\text{Skor ideal} - \text{Skor Aktual}}{\text{Skor Ideal}} \times 100\% \quad (2)$$

Description:

- Actual score is the answer of all respondents
- The ideal score is the highest score or value, or all respondents are assumed to choose the answer with the highest score.

Furthermore, these results are processed and calculated with the criteria set out in the study design.

Table 2. Percentage of success

% Total score	Criteria
20% - 36%	Not good
37% - 52%	Less good
53% - 68%	Enough
69% - 83%	Good
84% - 100%	Excellent

- Characteristics of Funtionality

The ability of the Software to provide the functionality required by the user, when

used under certain conditions.

Functionality Characteristic Testing Results:

Table 3. Functionality Testing Results

No	Indicator	Skor Aktual	Skor Ideal
1	Suitability	9814	2250
2	Accuracy	8995	2250
3	Security	8311	2250
	Jumlah	27120	33750

For Success percentage :

Skor Aktual :27120

Skor Ideal : 33750

$$= \frac{27120}{33750} \times 100\% \\ = 80,355 \%$$

For Error Value (error) using the formula :

$$= \frac{33750-27120}{33750} \times 100 \% \\ = 19,65 \%$$

Analyze the quality of functionality characteristics obtained a total value of 80.355%. Comparing the results of the respondents with the Likert scale, the value of 80.355% is included in the Good classification. This means that the I-Health application can be used in providing appropriate function facilities and displaying the results needed and can prevent unwanted access, such as avoiding data manipulation from other parties, After calculating the functionality for the percentage of errors in the I-Health application, it gets a value of 19.65%, which has a low error rate and good accuracy seeing the success rate at 80.335%. Avoiding errors when running the application is expected to affect the percentage of error values.



Figure 6. Functionality percentage chart

b. Usability Characteristics

The ability of the Software to understand, learn, use, and appeal to users when used under certain conditions.

Table 4. Usability Testing Results

No	Indicator	Skor Aktual	Skor Ideal
1	Understandibility	619	750

2	Learnability	600	750
3	Operability	607	750
4	Attractiveness	616	750
Total		2442	3000

For Success Percentage

Skor Actual : 2442

Skor Ideal : 3000

$$= \frac{2442}{3000} \times 100\% = 81,44\%$$

The percentage of success obtained for all usability sub-characteristics. A total value of 81.44% was obtained. Comparing the results of respondents with a Likert scale, 81.44% is included in the Good classification. This means that the I-Health application has an effortless display for users to understand and operate. With this level of success, users can run the application without taking a long time to learn the I-Health application. Next, calculate the error in the usability test for the I-Health application as follows. For the error value (error) using the formula :

$$= \frac{3000-2442}{3000} \times 100\% = 18,6\%$$

After calculating usability for the percentage of errors in the I-Health application, it gets a value of 18.6%, with a low error rate. The i-health application provides ease of understanding and has its appeal. Make it easy for patients to operate the application and understand what is in it.

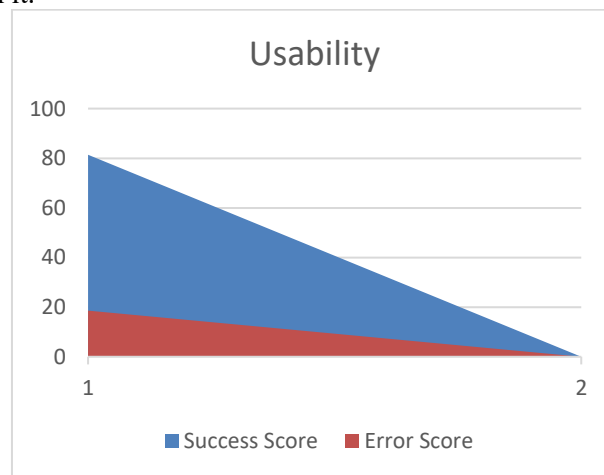

Figure 7. Usability Percentage Chart

c. Characteristics of efficiency

The Software can deliver appropriate performance relative to the resources used under the circumstances. In the Performance Efficiency aspect, testing is done by calculating the average response time of each task run. Testing the performance efficiency aspect is done at least five times by considering the response time when the application retrieves data from the server and then displays it in the system. The results are then compared with Table 1 about user satisfaction with response time.

Table 5. Average response time

Response Time (second)	Predicate
--------------------------	-----------

<3	Very Good
3-9	Satisfied
9-12	Satisfied Enough
>12	Dissatisfied

Efficiency Characteristic Testing Results:

Response Time Result

$$= \frac{\text{Average Time}}{\text{Total Respondent}}$$

Response Time = 55,51

Number of respondent = 50

$$= \frac{55,51}{50}$$

$$= 1,1102 \text{ s}$$

The I-Health application scored 1.11 seconds in efficiency testing, which is very good. Quality analysis of efficiency aspects is done by calculating the system's average response time to retrieve and display data. The result of testing the performance efficiency of the response time required by the system in performing specific tasks is 1.11 seconds. The user satisfaction table includes these results in the very satisfying category because it is less than 3 seconds.

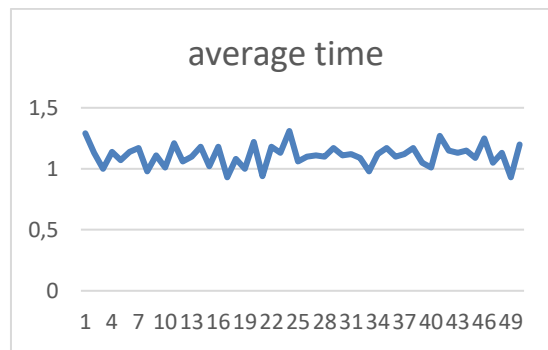

Figure 8. Average Efficiency Time Chart

4. Conclusion

I-Health is an application used in this study to display patient information and health status through device health monitoring. The I-Health application is available for Android and iOS. The mobile health app was evaluated according to ISO/EIC 9126 using functionality, suitability, and efficiency. The results were an 80% success rate in functionality testing, an 81% success rate in usability testing, and an average time to complete the specified tasks of 1.11 seconds. Multifunctional wireless health monitoring devices with displays on Android and iOS have great potential to improve individual health monitoring. Implications include changes in health behaviors, management of chronic diseases, and expanding the understanding of overall health. Future research should focus on developing functionality, integration, better user interface, data security, and privacy compliance.

5. Acknowledgements

The authors thank the Sriwijaya State Polytechnic for providing the research facilities. All research lecturers and technicians at the Telecommunications Laboratory, Department of Electrical Engineering, Sriwijaya Polytechnic, who assisted and offered their knowledge, are also thanked. We would also like to thank our colleagues in the Nursing and Facilities Study Program, Faculty of Nursing, University of Indonesia, for their helpful suggestions and support. Finally, we would like to acknowledge the affection and support of our family and friends throughout the research process. We could only have completed this research with their encouragement and assistance.

References

- [1] S. Gilbert, A. Pimenta, A. Stratton-Powell, C. Welzel, and T. Melvin, "Continuous Improvement of Digital Health Applications Linked to Real-World Performance Monitoring: Safe Moving Targets?," *Mayo Clinic Proceedings: Digital Health*, vol. 1, no. 3, pp. 276–287, Sep. 2023, doi: 10.1016/j.mcpdig.2023.05.010.
- [2] Y. Efendi, "Internet Of Things (IOT) Sistem Pengendalian Lampu Menggunakan Raspberry Pi Berbasis Mobile," *Jurnal Ilmiah Ilmu Komputer*, vol. 4, no. 1, 2018, [Online]. Available: <http://ejournal.fikom-unasman.ac.id>
- [3] C. Jiang, H. Xu, W. Jin, and X. Bi, "Research on application of power Internet of Things technology in leakage fault diagnosis of rural power grid," *Energy Reports*, vol. 9, pp. 847–854, Sep. 2023, doi: 10.1016/j.egy.2023.04.164.
- [4] R. Negra, I. Jemili, and A. Belghith, "Wireless Body Area Networks: Applications and Technologies," in *Procedia Computer Science*, Elsevier, 2016, pp. 1274–1281. doi: 10.1016/j.procs.2016.04.266.
- [5] S. A. Arnomo and H. Hendra, "Perbandingan Fitur Smartphone, Pemanfaatan Dan Tingkat Usability Pada Android Dan iOS Platforms," *InfoTekJar (Jurnal Nasional Informatika dan Teknologi Jaringan)*, vol. 3, no. 2, pp. 184–192, 2019, doi: 10.30743/infotekjar.v3i2.1002.
- [6] D. safitri and W. Aziiz Hari Mukti, "Pengaruh Penggunaan Aplikasi Android Berbantuan Appsgeyser.Com terhadap Hasil Belajar Siswa Pada Mata Pelajaran Ilmu Pengetahuan Sosial," Juni, 2021. [Online]. Available: <https://ejournal.iainbengkulu.ac.id/index.php/jpe>
- [7] J. Maylia Suhendro, M. Sudarma, D. Care Khrisne, and J. Raya Kampus Unud, "Juni 2021 Jauzaa Maylia Suhendro, Made Sudarma, Duman Care Khrisne 68."
- [8] L. G. Schiffman and L. Lazar. Kanuk, "Consumer behavior," p. 22, 2007, Accessed: Jul. 31, 2023. [Online]. Available: https://books.google.com/books/about/Consumer_Behavior.html?hl=id&id=vTRPngEACAAJ
- [9] S. Suryanti, D. Sutaji, T. Nusantara, and . S., "Online Learning Quality Measurement Application for Higher Education: Development and Analysis Using ISO 9126," *KnE Social Sciences*, May 2023, doi: 10.18502/kss.v8i9.13323.